

scale 1:1



tables

Price & Specification Guide

Version: 03.15.24
prices effective April 1, 2024

DeskMakers



tables

Price & Specification Guide

Table of Contents

Laminate Finishes	4-5
Ready-to-Ship Program	6-7
ThinkTank Table Tops	8-10
Kayak Table Tops	11-13
HotSpot Table Tops	14-15
Conference Table Frames	16-21
TeleMeet Table Tops	22-23
TeleMeet Table Frames	24-25
Training Table Tops and Frames	24-25
Nomad	26
Ping Pong Conference Tables	27
Terms and Conditions	28
Warranty	29

laminates finishes

"T1" standard thermofuse laminate (TFL)

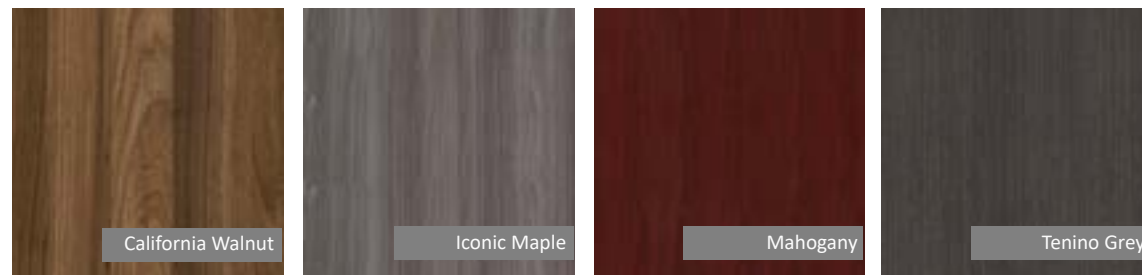
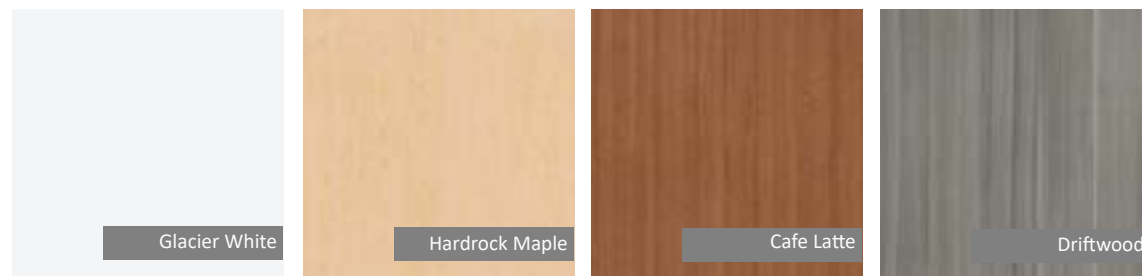

Matching 2MM PVC edgebanding is available for all Standard TFL finishes shown here.

For HPL match information please visit deskmakers.com/resources/materials

edges

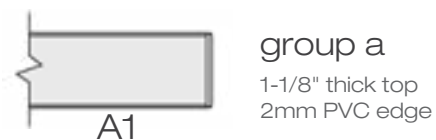

"T2" premium textured thermofuse laminate (TFL)

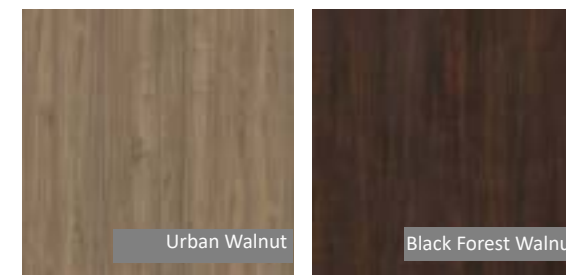
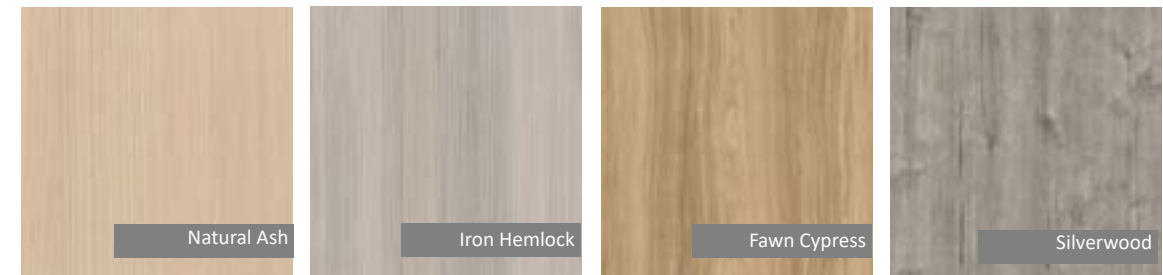

Premium TFLs require a 10% upcharge. Add item code OP-TTFL-1.

Matching 2MM PVC edgebanding is available for all Premium TFL finishes shown here.

For HPL match information please visit deskmakers.com/resources/materials

high pressure laminate (HPL)

"H1" Standard HPL

Pricing shown in this price list applies only to non-premium HPLs as follows:

- Wilsonart: Solids, Woodgrains, and Abstracts in Matte (-60) finish,
- Formica: Color Portfolio, Woodgrains, and Patterns in Matte (-58) finish
- Pionite: Solids, Woodgrains, and Abstracts in Suede (N) finish
- Arborite: Solids, Woodgrains, Textures and Abstracts in Matte (CA) finish
- Nevamar: Solids, Woodgrains, Stones and Abstracts in ARP (-T) finish

A minimum charge of \$520 net per HPL color will be applied to each order.

Call customer service for pricing for all other HPLs.

Additional lead times required for HPL orders depending on material availability and order complexity. HPL is always available with DeskMakers standard 2MM edgebanding. Special order matching PVC 2MM edgebanding may be available for orders \$25,000 List or larger, call customer service for pricing.

"H2" Premium HPL Finishes

Pricing shown in this price list applies only the specific premium HPLs listed below:

- White High Gloss Dry Erase - Formica White 949-90

Scale 1:1 Accent Edgebanding Options





A limited selection of Scale 1:1 product is available in stock and ready to ship within 3 days of order acknowledgement. Quantities are limited to 5 items or less - for larger rush orders or items in finishes or sizes other than those included in the program at right please contact customer service at 323-264-2260 or info@scale1to1.com.



pricing

Model Number	Width	Length	Height	Glacier White (T1)
THINKTANK				
SC-TKDW-4272-GWGW	42	72	29	\$3,056
SC-TKDW-4896-GWGW	48	96	29	\$3,484
SC-TKDW-4820-GWGW	48	120	29	\$4,768
SC-TKDW-4844-GWGW	48	144	29	\$6,003
KAYAK				
SC-KYDW-4820-GWGW	48	120	29	\$4,802
SC-KYDW-4844-GWGW	48	144	29	\$6,168
HOTSPOT - DESK HEIGHT				
SC-HSDW-3672-GWGW	36	72	29	\$3,102
SC-HSDW-3684-GWGW	36	84	29	\$3,282
SC-HSDW-3696-GWGW	36	96	29	\$3,446
HOTSPOT - BAR HEIGHT				
SC-HSBW-3672-GWGW	36	72	42	\$3,639
SC-HSBW-3684-GWGW	36	84	42	\$3,818
SC-HSBW-3696-GWGW	36	96	42	\$3,982
EYHOV SPORT				
SC-ESDW-6008-GWSY*	60	108	29	\$6,711
MARC MARKERBOARD				
SC-MCWB-4155-ABDE*	42	24	78	\$2,994
SC-MCWB-4155-SYDE*	42	24	78	\$2,994

- All tops are only available in Glacier White TFL/Matching PVC Edge unless otherwise noted:
 * EYHOV SPORT stocked in Glacier White Matte HPL with Storm Grey Edgeband.
 * Marc Markerboard stocked in both Arctic Blue or Storm Grey steel frame with Dry Erase Whiteboard.
 - All tables will ship with a pre-cut 3" white grommet in the center position. AC-PWRG-06-WT can be added to Ready-to-Ship orders for \$137 List. Tables are not available Ready-to-Ship without the grommet cut.
 - Two piece table tops are divided into two equal sections.

One Piece Table Tops

pricing



Model Number	Width	Length	T1	T2	H1	H2
42" Wide						
SC-THTK-4272-??-A1	42	72	\$920	\$1,013	\$1,351	\$1,592
SC-THTK-4278-??-A1	42	78	\$961	\$1,057	\$1,415	\$1,667
SC-THTK-4284-??-A1	42	84	\$985	\$1,084	\$1,465	\$1,726
SC-THTK-4290-??-A1	42	90	\$1,035	\$1,138	\$1,518	\$1,789
SC-THTK-4296-??-A1	42	96	\$1,078	\$1,186	\$1,581	\$1,864
48" Wide						
SC-THTK-4872-??-A1	48	72	\$945	\$1,039	\$1,389	\$1,637
SC-THTK-4878-??-A1	48	78	\$971	\$1,068	\$1,431	\$1,687
SC-THTK-4884-??-A1	48	84	\$999	\$1,099	\$1,491	\$1,758
SC-THTK-4890-??-A1	48	90	\$1,107	\$1,218	\$1,624	\$1,915
SC-THTK-4896-??-A1	48	96	\$1,176	\$1,293	\$1,724	\$2,032
54" Wide						
SC-THTK-5472-??-A1	54	72	\$966	\$1,063	\$1,424	\$1,679
SC-THTK-5478-??-A1	54	78	\$993	\$1,092	\$1,465	\$1,726
SC-THTK-5484-??-A1	54	84	\$1,116	\$1,228	\$1,657	\$1,953
SC-THTK-5490-??-A1	54	90	\$1,195	\$1,314	\$1,753	\$2,065
SC-THTK-5496-??-A1	54	96	\$1,376	\$1,514	\$2,020	\$2,381
60" Wide						
SC-THTK-6072-??-A1	60	72	\$1,041	\$1,145	\$1,540	\$1,815
SC-THTK-6078-??-A1	60	78	\$1,171	\$1,288	\$1,744	\$2,055
SC-THTK-6084-??-A1	60	84	\$1,266	\$1,392	\$1,892	\$2,230
SC-THTK-6090-??-A1	60	90	\$1,356	\$1,492	\$1,989	\$2,345
SC-THTK-6096-??-A1	60	96	\$1,473	\$1,620	\$2,161	\$2,547

- All tops have 2mm PVC edges and are only available with DeskMakers/Scale 1:1 standard 2MM PVC edgebanding.
 - For electrical options, please see pages 28-36.

how to order

Replace "???" with "T1" for standard TFL, "T2" for premium TFL, "H1" for standard HPL or "H2" for premium HPL. On your order, please specify edgeband finish if different than the top finish. See pages 4-5 for finish options.

Two Piece Table Tops

pricing

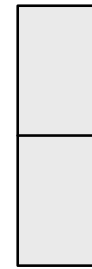

Model Number	Width	Length	T1	T2	H1	H2
42" Wide						
SC-THTK-4208-??-A1	42	108	\$1,637	\$1,800	\$2,447	\$2,884
SC-THTK-4220-??-A1	42	120	\$1,758	\$1,934	\$2,636	\$3,108
SC-THTK-4244-??-A1	42	144	\$1,955	\$2,151	\$2,869	\$3,381
SC-THTK-4268-??-A1	42	168	\$2,249	\$2,473	\$3,299	\$3,889
SC-THTK-4292-??-A1	42	192	\$2,655	\$2,920	\$3,895	\$4,591
48" Wide						
SC-THTK-4808-??-A1	48	108	\$1,833	\$2,017	\$2,756	\$3,248
SC-THTK-4820-??-A1	48	120	\$1,955	\$2,151	\$2,946	\$3,473
SC-THTK-4844-??-A1	48	144	\$2,249	\$2,473	\$3,299	\$3,889
SC-THTK-4868-??-A1	48	168	\$2,655	\$2,920	\$3,895	\$4,591
SC-THTK-4892-??-A1	48	192	\$3,076	\$3,384	\$4,514	\$5,321
54" Wide						
SC-THTK-5408-??-A1	54	108	\$2,061	\$2,267	\$3,110	\$3,665
SC-THTK-5420-??-A1	54	120	\$2,261	\$2,487	\$3,425	\$4,037
SC-THTK-5444-??-A1	54	144	\$2,494	\$2,743	\$3,659	\$4,313
SC-THTK-5468-??-A1	54	168	\$2,887	\$3,176	\$4,236	\$4,992
SC-THTK-5492-??-A1	54	192	\$3,345	\$3,680	\$4,908	\$5,784
60" Wide						
SC-THTK-6008-??-A1	60	108	\$2,250	\$2,475	\$3,406	\$4,014
SC-THTK-6020-??-A1	60	120	\$2,476	\$2,723	\$3,761	\$4,432
SC-THTK-6044-??-A1	60	144	\$2,726	\$2,998	\$4,000	\$4,714
SC-THTK-6068-??-A1	60	168	\$3,155	\$3,471	\$4,630	\$5,457
SC-THTK-6092-??-A1	60	192	\$3,659	\$4,025	\$5,369	\$6,328

- All tops have 2mm PVC edges and are only available with DeskMakers/Scale 1:1 standard 2MM PVC edgebanding.
 - For two piece and three piece table tops, please note that the grain pattern will not line up at the seams.
 - Two piece table tops are divided into two equal sections.
 - For electrical options, please see pages 28-36.

how to order

Replace "???" with "T1" for standard TFL, "T2" for premium TFL, "H1" for standard HPL or "H2" for premium HPL. On your order, please specify edgeband finish if different than the top finish. See pages 4-5 for finish options.

ThinkTank

Rectangular Table Tops

Three Piece Table Tops

pricing



Model Number	Width	Length	T1	T2	H1	H2
42" Wide						
SC-THTK-4216-??-A1	42	216	\$3,438	\$3,782	\$5,046	\$5,947
SC-THTK-4240-??-A1	42	240	\$3,894	\$4,283	\$5,714	\$6,734
SC-THTK-4264-??-A1	42	264	\$4,793	\$5,272	\$7,034	\$8,290
SC-THTK-4288-??-A1	42	288	\$5,171	\$5,688	\$7,589	\$8,944
48" Wide						
SC-THTK-4816-??-A1	48	216	\$3,815	\$4,197	\$5,598	\$6,598
SC-THTK-4840-??-A1	48	240	\$4,328	\$4,761	\$6,350	\$7,485
SC-THTK-4864-??-A1	48	264	\$5,254	\$5,779	\$7,709	\$9,085
SC-THTK-4888-??-A1	48	288	\$6,381	\$7,019	\$9,363	\$11,034
54" Wide						
SC-THTK-5416-??-A1	54	216	\$4,192	\$4,612	\$6,151	\$7,250
SC-THTK-5440-??-A1	54	240	\$4,761	\$5,237	\$6,987	\$8,235
SC-THTK-5464-??-A1	54	264	\$5,713	\$6,285	\$8,384	\$9,881
SC-THTK-5488-??-A1	54	288	\$7,590	\$8,349	\$11,137	\$13,126
60" Wide						
SC-THTK-6016-??-A1	60	216	\$4,571	\$5,028	\$6,706	\$7,904
SC-THTK-6040-??-A1	60	240	\$5,197	\$5,716	\$7,625	\$8,987
SC-THTK-6064-??-A1	60	264	\$6,563	\$7,219	\$9,631	\$11,351
SC-THTK-6088-??-A1	60	288	\$8,168	\$8,984	\$11,985	\$14,125

- All tops have 2mm PVC edges and are only available with DeskMakers/Scale 1:1 standard 2MM PVC edgebanding.
- For two piece and three piece table tops, please note that the grain pattern will not line up at the seams.
- Three piece table tops are divided into three equal sections.
- For electrical options, please see pages 28-36.

how to order

Replace "???" with "T1" for standard TFL, "T2" for premium TFL, "H1" for standard HPL or "H2" for premium HPL. On your order, please specify edgeband finish if different than the top finish. See pages 4-5 for finish options.

Kayak

Boatshape Table Tops

One Piece Table Tops

pricing



Model Number	Width	Length	T1	T2	H1	H2
42" Wide						
SC-KYAK-4284-??-A1	42/28	84	\$1,106	\$1,216	\$2,000	\$2,357
SC-KYAK-4296-??-A1	42/28	96	\$1,228	\$1,351	\$2,259	\$2,663
48" Wide						
SC-KYAK-4884-??-A1	48/34	84	\$1,200	\$1,320	\$2,196	\$2,588
SC-KYAK-4896-??-A1	48/34	96	\$1,323	\$1,455	\$2,455	\$2,894
54" Wide						
SC-KYAK-5484-??-A1	54/40	84	\$1,295	\$1,425	\$2,397	\$2,825
SC-KYAK-5496-??-A1	54/40	96	\$1,418	\$1,560	\$2,654	\$3,128
60" Wide						
SC-KYAK-6084-??-A1	60/46	84	\$1,390	\$1,529	\$2,595	\$3,059
SC-KYAK-6096-??-A1	60/46	96	\$1,512	\$1,663	\$2,853	\$3,362

- All tops have 2mm PVC edges and are only available with DeskMakers/Scale 1:1 standard 2MM PVC edgebanding.
- For electrical options, please see pages 28-36.

how to order

Replace "???" with "T1" for standard TFL, "T2" for premium TFL, "H1" for standard HPL or "H2" for premium HPL. On your order, please specify edgeband finish if different than the top finish. See pages 4-5 for finish options.



Kayak

Boatshape Table Tops

Two Piece Table Tops

pricing

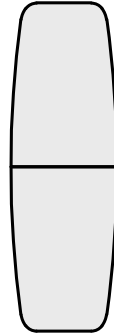

Model Number	Width	Length	T1	T2	H1	H2
42" Wide						
SC-KYAK-4220-??-A1	42/28	120	\$1,742	\$1,916	\$2,774	\$3,269
SC-KYAK-4244-??-A1	42/28	144	\$2,153	\$2,369	\$3,160	\$3,724
48" Wide						
SC-KYAK-4820-??-A1	48/34	120	\$1,990	\$2,188	\$3,193	\$3,763
SC-KYAK-4844-??-A1	48/34	144	\$2,424	\$2,666	\$3,557	\$4,192
SC-KYAK-4868-??-A1	48/34	168	\$2,826	\$3,109	\$4,148	\$4,888
SC-KYAK-4892-??-A1	48/34	192	\$3,268	\$3,595	\$4,795	\$5,651
54" Wide						
SC-KYAK-5420-??-A1	54/40	120	\$2,351	\$2,586	\$3,564	\$4,201
SC-KYAK-5444-??-A1	54/40	144	\$2,694	\$2,964	\$3,953	\$4,659
SC-KYAK-5468-??-A1	54/40	168	\$3,117	\$3,429	\$4,575	\$5,391
SC-KYAK-5492-??-A1	54/40	192	\$3,612	\$3,973	\$5,301	\$6,248
60" Wide						
SC-KYAK-6020-??-A1	60/46	120	\$2,576	\$2,834	\$4,052	\$4,776
SC-KYAK-6044-??-A1	60/46	144	\$2,940	\$3,235	\$4,723	\$5,566
SC-KYAK-6068-??-A1	60/46	168	\$3,408	\$3,748	\$5,001	\$5,894
SC-KYAK-6092-??-A1	60/46	192	\$3,955	\$4,350	\$5,804	\$6,841

- All tops have 2mm PVC edges and are only available with DeskMakers/Scale 1:1 standard 2MM PVC edgebanding.
- For two piece and three piece table tops, please note that the grain pattern will not line up at the seams.
- Two piece table tops are divided into two equal sections.
- For electrical options, please see pages 28-36.

how to order

Replace "???" with "T1" for standard TFL, "T2" for premium TFL, "H1" for standard HPL or "H2" for premium HPL. On your order, please specify edgeband finish if different than the top finish. See pages 4-5 for finish options.

Kayak

Boatshape Table Tops

Three Piece Table Tops

pricing



Model Number	Width	Length	T1	T2	H1	H2
48" Wide						
SC-KYAK-4816-??-A1	48/34	216	\$4,107	\$4,518	\$6,026	\$7,102
SC-KYAK-4840-??-A1	48/34	240	\$4,658	\$5,124	\$6,834	\$8,055
SC-KYAK-4864-??-A1	48/34	264	\$5,655	\$6,220	\$8,298	\$9,780
SC-KYAK-4888-??-A1	48/34	288	\$6,871	\$7,558	\$10,084	\$11,885
54" Wide						
SC-KYAK-5416-??-A1	54/40	216	\$4,516	\$4,968	\$6,626	\$7,809
SC-KYAK-5440-??-A1	54/40	240	\$5,131	\$5,644	\$7,529	\$8,874
SC-KYAK-5464-??-A1	54/40	264	\$6,151	\$6,767	\$9,026	\$10,637
SC-KYAK-5488-??-A1	54/40	288	\$8,178	\$8,995	\$11,999	\$14,133
60" Wide						
SC-KYAK-6016-??-A1	60/46	216	\$4,925	\$5,417	\$7,226	\$8,517
SC-KYAK-6040-??-A1	60/46	240	\$5,603	\$6,163	\$8,220	\$9,689
SC-KYAK-6064-??-A1	60/46	264	\$7,069	\$7,776	\$10,372	\$12,224
SC-KYAK-6088-??-A1	60/46	288	\$8,802	\$9,683	\$12,916	\$15,222

- All tops have 2mm PVC edges and are only available with DeskMakers/Scale 1:1 standard 2MM PVC edgebanding.
- For two piece and three piece table tops, please note that the grain pattern will not line up at the seams.
- Three piece table tops are divided into three equal sections.
- For electrical options, please see pages 28-36.

how to order

Replace "???" with "T1" for standard TFL, "T2" for premium TFL, "H1" for standard HPL or "H2" for premium HPL. On your order, please specify edgeband finish if different than the top finish. See pages 4-5 for finish options.

HOT SPOT

Radius Corner Table Tops

One Piece Table Tops

pricing

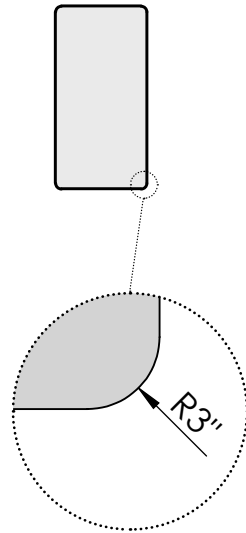

Model Number	Width	Length	T1	T2	H1	H2
36" Wide						
SC-HTSP-3672-??-A1	36	72	\$964	\$1,060	\$1,413	\$1,666
SC-HTSP-3684-??-A1	36	84	\$1,050	\$1,155	\$1,540	\$1,816
SC-HTSP-3696-??-A1	36	96	\$1,136	\$1,250	\$1,667	\$1,965
42" Wide						
SC-HTSP-4272-??-A1	42	72	\$997	\$1,096	\$1,553	\$1,830
SC-HTSP-4284-??-A1	42	84	\$1,069	\$1,176	\$1,685	\$1,986
SC-HTSP-4296-??-A1	42	96	\$1,169	\$1,286	\$1,734	\$2,045
48" Wide						
SC-HTSP-4872-??-A1	48	72	\$1,023	\$1,126	\$1,597	\$1,882
SC-HTSP-4884-??-A1	48	84	\$1,083	\$1,191	\$1,714	\$2,020
SC-HTSP-4896-??-A1	48	96	\$1,277	\$1,405	\$1,898	\$2,236
54" Wide						
SC-HTSP-5472-??-A1	54	72	\$1,049	\$1,154	\$1,638	\$1,930
SC-HTSP-5484-??-A1	54	84	\$1,212	\$1,334	\$1,906	\$2,246
SC-HTSP-5496-??-A1	54	96	\$1,499	\$1,649	\$2,239	\$2,638
60" Wide						
SC-HTSP-6072-??-A1	60	72	\$1,130	\$1,243	\$1,771	\$2,087
SC-HTSP-6084-??-A1	60	84	\$1,376	\$1,514	\$2,177	\$2,566
SC-HTSP-6096-??-A1	60	96	\$1,606	\$1,767	\$2,401	\$2,830

- All tops have 2mm PVC edges and are only available with DeskMakers/Scale 1:1 standard 2MM PVC edgebanding.
- For electrical options, please see pages 28-36.
- Hot Spot tables have 3" radius corners.

how to order

Replace "???" with "T1" for standard TFL, "T2" for premium TFL, "H1" for standard HPL or "H2" for premium HPL. On your order, please specify edgeband finish if different than the top finish. See pages 4-5 for finish options.



HOT SPOT

Radius Corner Table Tops

Two Piece Table Tops

pricing

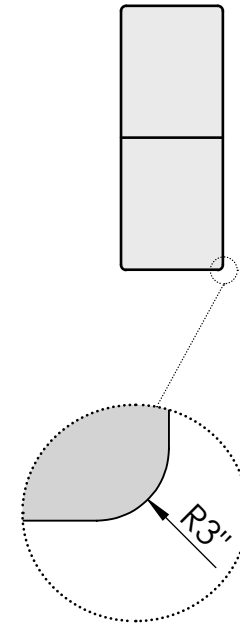

Model Number	Width	Length	T1	T2	H1	H2
36" Wide						
SC-HTSP-3620-??-A1	36	120	\$1,697	\$1,867	\$2,492	\$2,937
SC-HTSP-3644-??-A1	36	144	\$1,808	\$1,989	\$2,653	\$3,126
SC-HTSP-3668-??-A1	36	168	\$2,007	\$2,208	\$2,946	\$3,473
SC-HTSP-3692-??-A1	36	192	\$2,436	\$2,680	\$3,576	\$4,215
42" Wide						
SC-HTSP-4220-??-A1	42	120	\$1,915	\$2,106	\$3,032	\$3,573
SC-HTSP-4244-??-A1	42	144	\$2,132	\$2,345	\$3,190	\$3,760
SC-HTSP-4268-??-A1	42	168	\$3,914	\$4,306	\$3,684	\$4,342
SC-HTSP-4292-??-A1	42	192	\$2,900	\$3,190	\$4,369	\$5,150
48" Wide						
SC-HTSP-4820-??-A1	48	120	\$2,132	\$2,345	\$3,389	\$3,994
SC-HTSP-4844-??-A1	48	144	\$2,454	\$2,700	\$3,684	\$4,342
SC-HTSP-4868-??-A1	48	168	\$2,900	\$3,190	\$4,369	\$5,150
SC-HTSP-4892-??-A1	48	192	\$3,365	\$3,701	\$5,082	\$5,989
54" Wide						
SC-HTSP-5420-??-A1	54	120	\$2,469	\$2,716	\$3,939	\$4,643
SC-HTSP-5444-??-A1	54	144	\$2,723	\$2,996	\$4,099	\$4,831
SC-HTSP-5468-??-A1	54	168	\$3,155	\$3,471	\$4,760	\$5,610
SC-HTSP-5492-??-A1	54	192	\$3,660	\$4,026	\$5,534	\$6,522
60" Wide						
SC-HTSP-6020-??-A1	60	120	\$2,704	\$2,975	\$4,326	\$5,098
SC-HTSP-6044-??-A1	60	144	\$2,979	\$3,276	\$4,490	\$5,293
SC-HTSP-6068-??-A1	60	168	\$3,452	\$3,797	\$5,215	\$6,146
SC-HTSP-6092-??-A1	60	192	\$4,004	\$4,405	\$6,067	\$7,150

- All tops have 2mm PVC edges and are only available with DeskMakers/Scale 1:1 standard 2MM PVC edgebanding.
- Hot Spot tables have 3" radius corners.
- For two piece and three piece table tops, please note that the grain pattern will not line up at the seams.
- Two piece table tops are divided into two equal sections.
- For electrical options, please see pages 28-36.

how to order

Replace "???" with "T1" for standard TFL, "T2" for premium TFL, "H1" for standard HPL or "H2" for premium HPL. On your order, please specify edgeband finish if different than the top finish. See pages 4-5 for finish options.

Table Bases

29" Desk Height

For 36", 42" and 48" Wide Table Tops

pricing

Model Number	Table Width	Table Length	Base Size	# of Legs	Price
2 Bases					
SC-BDH2-3278	36, 42, 48	72, 78	31-1/2	2	\$2,138
SC-BDH2-3290	36, 42, 48	84, 90	31-1/2	2	\$2,232
SC-BDH2-3296	36, 42, 48	96	31-1/2	2	\$2,308
SC-BDH2-3220	36, 42, 48	108, 120	31-1/2	2	\$2,812
3 Bases					
SC-BDH3-3256	36, 42, 48	144	31-1/2	3	\$3,755
SC-BDH3-3280	36, 42, 48	168	31-1/2	3	\$4,062
SC-BDH3-3292	36, 42, 48	192	31-1/2	3	\$4,202
4 Bases					
SC-BDH4-3216	36, 42, 48	216	31-1/2	4	\$5,588
SC-BDH4-3240	36, 42, 48	240	31-1/2	4	\$5,680
SC-BDH4-3264	36, 42, 48	264	31-1/2	4	\$5,868
SC-BDH4-3288	36, 42, 48	288	31-1/2	4	\$6,096

- Bases and frames are constructed of steel with a white powdercoat finish.
- Includes leveling glides.
- Shipped in pieces and require assembly.



Table Bases

29" Desk Height

For 54" and 60" Wide Table Tops

pricing

Model Number	Table Width	Table Length	Base Size	# of Legs	Price
2 Bases					
SC-BDH2-4478	54, 60	72, 78	43-1/2	2	\$2,630
SC-BDH2-4490	54, 60	84, 90	43-1/2	2	\$2,724
SC-BDH2-4496	54, 60	96	43-1/2	2	\$2,800
SC-BDH2-4420	54, 60	108, 120	43-1/2	2	\$3,304
3 Bases					
SC-BDH3-4456	54, 60	144	43-1/2	3	\$4,436
SC-BDH3-4480	54, 60	168	43-1/2	3	\$4,800
SC-BDH3-4492	54, 60	192	43-1/2	3	\$4,940
4 Bases					
SC-BDH4-4416	54, 60	216	43-1/2	4	\$6,572
SC-BDH4-4440	54, 60	240	43-1/2	4	\$6,664
SC-BDH4-4464	54, 60	264	43-1/2	4	\$6,852
SC-BDH4-4488	54, 60	288	43-1/2	4	\$7,080

- Bases and frames are constructed of steel with a white powdercoat finish.
- Includes leveling glides.
- Shipped in pieces and require assembly.

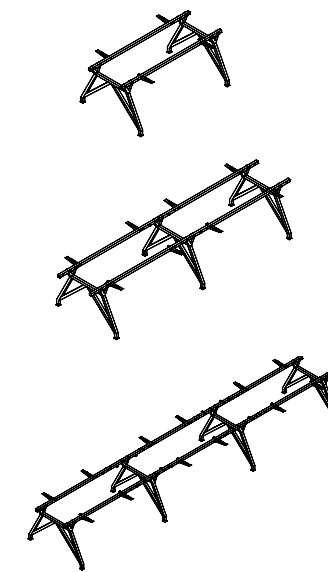

Table Bases

37" Counter Height

For 36", 42" and 48" Wide Table Tops

pricing

Model Number	Table Width	Table Length	Base Size	# of Legs	Price
2 Bases					
SC-BCH2-3278	36, 42, 48	54, 60, 72, 78	31-1/2	2	\$2,338
SC-BCH2-3290	36, 42, 48	84, 90	31-1/2	2	\$2,432
SC-BCH2-3208	36, 42, 48	96, 108	31-1/2	2	\$2,508
SC-BCH2-3220	36, 42, 48	120	31-1/2	2	\$3,012

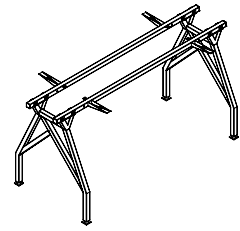

Counter Height with levelers

- Bases and frames are constructed of steel with a white powdercoat finish.
- Includes leveling glides.
- Shipped in pieces and require assembly.

pricing

Model Number	Table Width	Table Length	Base Size	# of Legs	Price
2 Bases					
SC-BCHC-3278	36, 42, 48	54, 60, 72, 78	31-1/2	2	\$2,586
SC-BCHC-3290	36, 42, 48	84, 90	31-1/2	2	\$2,680
SC-BCHC-3208	36, 42, 48	96, 108	31-1/2	2	\$2,756
SC-BCHC-3220	36, 42, 48	120	31-1/2	2	\$3,260

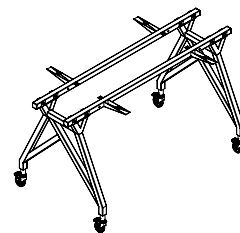

Counter Height with casters

- Bases and frames are constructed of steel with a white powdercoat finish.
- Includes locking casters.
- Shipped in pieces and require assembly.

Table Bases

37" Counter Height

For 54" and 60" Wide Table Tops

pricing

Model Number	Table Width	Table Length	Base Size	# of Legs	Price
2 Bases					
SC-BSH2-4478	54, 60	72, 78	43-1/2	2	\$3,038
SC-BSH2-4490	54, 60	84, 90	43-1/2	2	\$3,132
SC-BSH2-4408	54, 60	96, 108	43-1/2	2	\$3,208
SC-BSH2-4420	54, 60	120	43-1/2	2	\$3,712

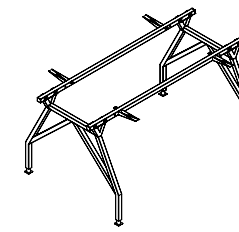

Counter Height with levelers

- Bases and frames are constructed of steel with a white powdercoat finish.
- Includes leveling glides.
- Shipped in pieces and require assembly.

pricing

Model Number	Table Width	Table Length	Base Size	# of Legs	Price
2 Bases					
SC-BCHC-4478	54, 60	54, 60, 72, 78	43-1/2	2	\$3,078
SC-BCHC-4490	54, 60	84, 90	43-1/2	2	\$3,172
SC-BCHC-4408	54, 60	96, 108	43-1/2	2	\$3,248
SC-BCHC-4420	54, 60	120	43-1/2	2	\$3,752

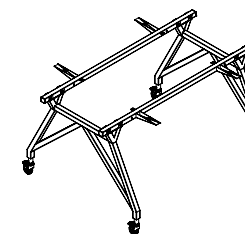

Counter Height with casters

- Bases and frames are constructed of steel with a white powdercoat finish.
- Includes locking casters.
- Shipped in pieces and require assembly.



Table Bases

42" Bar Height

For 36", 42" and 48" Wide Table Tops

pricing

Model Number	Table Width	Table Length	Base Size	# of Legs	Price
2 Bases					
SC-BSH2-3278	36, 42, 48	72, 78	31-1/2	2	\$2,498
SC-BSH2-3290	36, 42, 48	84, 90	31-1/2	2	\$2,592
SC-BSH2-3208	36, 42, 48	96, 108	31-1/2	2	\$2,668
SC-BSH2-3220	36, 42, 48	120	31-1/2	2	\$3,172

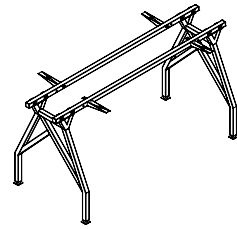

Standing Height with levelers

- Bases and frames are constructed of steel with a white powdercoat finish.
- Includes leveling glides.
- Shipped in pieces and require assembly.

pricing

Model Number	Table Width	Table Length	Base Size	# of Legs	Price
2 Bases					
SC-BSHC-3278	36, 42, 48	54, 60, 72, 78	31-1/2	2	\$2,786
SC-BSHC-3290	36, 42, 48	84, 90	31-1/2	2	\$2,880
SC-BSHC-3208	36, 42, 48	96, 108	31-1/2	2	\$2,956
SC-BSHC-3220	36, 42, 48	120	31-1/2	2	\$3,460

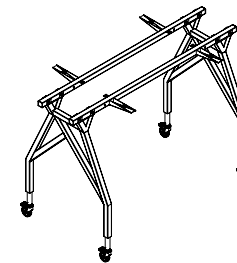

Standing Height with casters

- Bases and frames are constructed of steel with a white powdercoat finish.
- Includes locking casters.
- Shipped in pieces and require assembly.

Table Bases

42" Bar Height

For 54" and 60" Wide Table Tops

pricing

Model Number	Table Width	Table Length	Base Size	# of Legs	Price
2 Bases					
SC-BSH2-4478	54, 60	72, 78	43-1/2	2	\$3,038
SC-BSH2-4490	54, 60	84, 90	43-1/2	2	\$3,132
SC-BSH2-4408	54, 60	96, 108	43-1/2	2	\$3,208
SC-BSH2-4420	54, 60	120	43-1/2	2	\$3,712

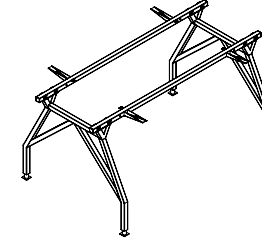

Standing Height with levelers

- Bases and frames are constructed of steel with a white powdercoat finish.
- Includes leveling glides.
- Shipped in pieces and require assembly.

pricing

Model Number	Table Width	Table Length	Base Size	# of Legs	Price
2 Bases					
SC-BSHC-4478	54, 60	54, 60, 72, 78	43-1/2	2	\$3,330
SC-BSHC-4490	54, 60	84, 90	43-1/2	2	\$3,424
SC-BSHC-4408	54, 60	96, 108	43-1/2	2	\$3,500
SC-BSHC-4420	54, 60	120	43-1/2	2	\$4,004

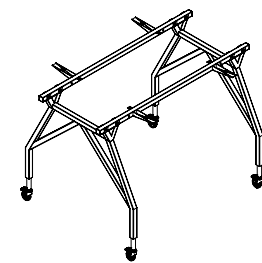

Standing Height with casters

- Bases and frames are constructed of steel with a white powdercoat finish.
- Includes locking casters.
- Shipped in pieces and require assembly.

D Shape

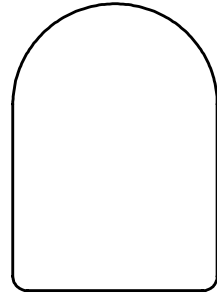

pricing

Model Number	Width	Length	T1	T2	H1	H2
36" Wide						
SC-TELD-3654-??-A1	36	54	\$971	\$1,068	\$1,351	\$1,592
SC-TELD-3660-??-A1	36	60	\$1,063	\$1,169	\$1,485	\$1,750
SC-TELD-3672-??-A1	36	72	\$1,145	\$1,260	\$1,605	\$1,892
42" Wide						
SC-TELD-4254-??-A1	42	54	\$1,050	\$1,155	\$1,466	\$1,728
SC-TELD-4260-??-A1	42	60	\$1,121	\$1,233	\$1,570	\$1,850
SC-TELD-4272-??-A1	42	72	\$1,212	\$1,334	\$1,706	\$2,010
SC-TELD-4284-??-A1	42	84	\$1,304	\$1,434	\$1,839	\$2,167
SC-TELD-4296-??-A1	42	96	\$1,395	\$1,535	\$1,972	\$2,324
48" Wide						
SC-TELD-4854-??-A1	48	54	\$1,129	\$1,242	\$1,582	\$1,865
SC-TELD-4860-??-A1	48	60	\$1,179	\$1,297	\$1,657	\$1,969
SC-TELD-4872-??-A1	48	72	\$1,279	\$1,406	\$1,802	\$2,125
SC-TELD-4884-??-A1	48	84	\$1,379	\$1,517	\$1,948	\$2,296
SC-TELD-4896-??-A1	48	96	\$1,478	\$1,626	\$2,094	\$2,467
54" Wide						
SC-TELD-5460-??-A1	54	60	\$1,238	\$1,362	\$1,741	\$2,052
SC-TELD-5472-??-A1	54	72	\$1,345	\$1,479	\$1,900	\$2,240
SC-TELD-5484-??-A1	54	84	\$1,452	\$1,598	\$2,058	\$2,425
SC-TELD-5496-??-A1	54	96	\$1,560	\$1,716	\$2,217	\$2,614

- All tops have 2mm PVC edges and are only available with DeskMakers/Scale 1:1 standard 2MM PVC edgebanding.
 - For electrical options, please see pages 28-36.

how to order

Replace "???" with "T1" for standard TFL, "T2" for premium TFL, "H1" for standard HPL or "H2" for premium HPL. On your order, please specify edgeband finish if different than the top finish. See pages 4-5 for finish options.

Boat Shape

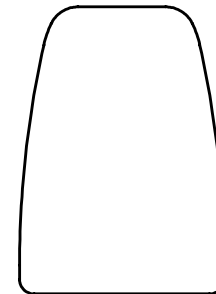

pricing

Model Number	Width	Length	T1	T2	H1	H2
42" Wide						
SC-TELB-4254-??-A1	42/28	54	\$1,187	\$1,306	\$1,668	\$1,966
SC-TELB-4260-??-A1	42/28	60	\$1,315	\$1,447	\$1,855	\$2,187
SC-TELB-4272-??-A1	42/28	72	\$1,425	\$1,567	\$2,016	\$2,376
SC-TELB-4284-??-A1	42/28	84	\$1,534	\$1,687	\$2,177	\$2,566
SC-TELB-4296-??-A1	42/28	96	\$1,643	\$1,807	\$2,338	\$2,756
48" Wide						
SC-TELB-4854-??-A1	48/34	54	\$1,300	\$1,430	\$1,832	\$2,159
SC-TELB-4860-??-A1	48/34	60	\$1,384	\$1,522	\$1,959	\$2,309
SC-TELB-4872-??-A1	48/34	72	\$1,506	\$1,656	\$2,133	\$2,514
SC-TELB-4884-??-A1	48/34	84	\$1,624	\$1,786	\$2,308	\$2,721
SC-TELB-4896-??-A1	48/34	96	\$1,743	\$1,918	\$2,484	\$2,928
54" Wide						
SC-TELB-5460-??-A1	54/40	60	\$1,454	\$1,599	\$2,060	\$2,427
SC-TELB-5472-??-A1	54/40	72	\$1,585	\$1,743	\$2,251	\$2,653
SC-TELB-5484-??-A1	54/40	84	\$1,714	\$1,885	\$2,440	\$2,877
SC-TELB-5496-??-A1	54/40	96	\$1,844	\$2,028	\$2,631	\$3,105

- All tops have 2mm PVC edges and are only available with DeskMakers/Scale 1:1 standard 2MM PVC edgebanding.
 - For electrical options, please see pages 28-36.

how to order

Replace "???" with "T1" for standard TFL, "T2" for premium TFL, "H1" for standard HPL or "H2" for premium HPL. On your order, please specify edgeband finish if different than the top finish. See pages 4-5 for finish options.

TeleMeet Bases

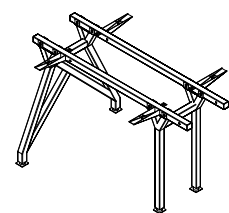
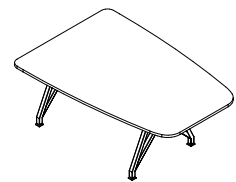

Desk Height with levelers

Desk Height (29") - for use on 36" wide D-Tops

pricing

Model Number	Table Width	Table Length	Base Size	# of Legs	Price
2 Bases					
SC-BDTH-3260	36	54, 60	31-1/2	2	\$2,191
SC-BDTH-3272	36	72	31-1/2	2	\$2,285

- Bases and frames are constructed of steel with a white powdercoat finish.
- Includes leveling glides.
- Shipped in pieces and require assembly.

Desk Height (29")

pricing

Model Number	Table Width	Table Length	Base Size	# of Legs	Price
2 Bases					
SC-BDTE-3260	42, 48, 54	54, 60	31-1/2	2	\$2,346
SC-BDTE-3272	42, 48, 54	72	31-1/2	2	\$2,440
SC-BDTE-3284	42, 48, 54	84	31-1/2	2	\$2,516
SC-BDTE-3296	42, 48, 54	96	31-1/2	2	\$2,768

- Bases and frames are constructed of steel with a white powdercoat finish.
- Includes leveling glides.
- Shipped in pieces and require assembly.

Counter Height (37")

pricing

Model Number	Table Width	Table Length	Base Size	# of Legs	Price
2 Bases					
SC-BCTE-3260	36, 42, 48, 54	54, 60	31-1/2	2	\$2,546
SC-BCTE-3272	36, 42, 48, 54	72	31-1/2	2	\$2,640
SC-BCTE-3284	36, 42, 48, 54	84	31-1/2	2	\$2,716
SC-BCTE-3296	36, 42, 48, 54	96	31-1/2	2	\$2,968

- Bases and frames are constructed of steel with a white powdercoat finish.
- Includes leveling glides.
- Shipped in pieces and require assembly.

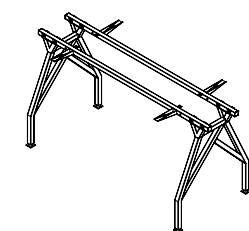

Counter Height with levelers

Media Panel

Laminate Media Panel



pricing

Model Number	Width	Height	T1	T2	H1	H2
SC-TMPL-3630-??	36	30	\$1,115	\$1,163	\$1,489	\$1,641
SC-TMPL-4230-??	42	30	\$1,194	\$1,249	\$1,631	\$1,808
SC-TMPL-4836-??	48	36	\$1,274	\$1,337	\$1,772	\$1,974
SC-TMPL-5436-??	54	36	\$1,359	\$1,431	\$1,925	\$2,154

- Metal frame and hardware to attach panel to TeleMeet table included. Will not pair with other tables.
- TV mount included. TV size should not exceed the width of the media panel.

Training Tables

Table Tops

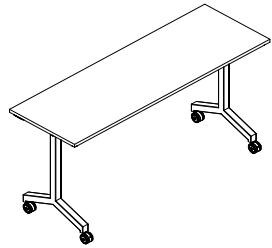

pricing

Model Number	Width	Length	T1	T2	H1	H2
18" Wide						
SC-TTBL-1848-??-A1	18	48	\$517	\$568	\$694	\$817
SC-TTBL-1860-??-A1	18	60	\$565	\$621	\$770	\$908
SC-TTBL-1872-??-A1	18	72	\$612	\$673	\$843	\$994
21" Wide						
SC-TTBL-2148-??-A1	21	48	\$542	\$596	\$733	\$864
SC-TTBL-2160-??-A1	21	60	\$587	\$645	\$804	\$947
SC-TTBL-2172-??-A1	21	72	\$649	\$714	\$901	\$1,062
24" Wide						
SC-TTBL-2448-??-A1	24	48	\$566	\$623	\$771	\$909
SC-TTBL-2460-??-A1	24	60	\$607	\$668	\$835	\$985
SC-TTBL-2472-??-A1	24	72	\$683	\$751	\$954	\$1,124
27" Wide						
SC-TTBL-2748-??-A1	27	48	\$595	\$655	\$818	\$963
SC-TTBL-2760-??-A1	27	60	\$641	\$705	\$888	\$1,047
SC-TTBL-2772-??-A1	27	72	\$721	\$793	\$1,015	\$1,196
30" Wide						
SC-TTBL-3048-??-A1	30	48	\$625	\$687	\$862	\$1,016
SC-TTBL-3060-??-A1	30	60	\$674	\$742	\$941	\$1,110
SC-TTBL-3072-??-A1	30	72	\$758	\$834	\$1,072	\$1,264

- All tops have 2mm PVC edges and are only available with DeskMakers/Scale 1:1 standard 2MM PVC edgebanding.
- Scale 1:1 Training Table tops are pre-drilled to specifically be used with the Scale 1:1 Flip-Top Frames
- For radius corners use OP-EDGE-RND for \$156 List per top for 4" radius corners.
- For electrical options, please see pages 28-36.

how to order

Replace "???" with "T1" for standard TFL, "T2" for premium TFL, "H1" for standard HPL or "H2" for premium HPL. On your order, please specify edgeband finish if different than the top finish. See pages 4-5 for finish options.



Training Tables

Flip-Top Frames

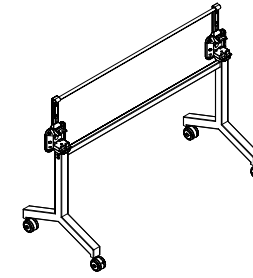

pricing

Model Number	Table Width	Table Length	Base Size	# of Legs	Price
Desk Height					
SC-TT17-01-48-SET	18, 21	48	17	2	\$1,239
SC-TT17-01-60-SET	18, 21	60	17	2	\$1,448
SC-TT17-01-72-SET	18, 21	72	17	2	\$1,561
Desk Height					
SC-TT22-01-48-SET	24, 27, 30	48	22	2	\$1,215
SC-TT22-01-60-SET	24, 27, 30	60	22	2	\$1,424
SC-TT22-01-72-SET	24, 27, 30	72	22	2	\$1,537
Counter Height (36")					
SC-TT22-04-48-SET	24	48	22	2	\$1,329
SC-TT22-04-60-SET	24	60	22	2	\$1,538
SC-TT22-04-72-SET	24	72	22	2	\$1,651

- Bases and frames are constructed of steel with a white powdercoat finish.
- Includes locking casters.
- Shipped in pieces and require assembly.
- (4x) ganging brackets included per table frame.



pricing

Table Tops

Model Number	Width	Length	H1	H2
NOMAD 10' Tables				
SC-NOMT-4820-??-A1	48	120	\$3,093	\$3,646
SC-NOMT-5420-??-A1	54	120	\$3,597	\$4,239
NOMAD 12' Tables				
SC-NOMT-4840-??-A1	48	140	\$3,364	\$3,964

- HPL tops with 2mm PVC edges are only available with Scale 1:1 standard 2MM PVC edgebanding.
- High gloss dry-erase finish must be specified for a "2 in 1" conference table and whiteboard.
- Whiteboard finish is H2 pricing. Woodgrain or matte color laminates cannot be used as whiteboard/dry-erase surface.
- For electrical options, please see pages 28-36.

Frames

Model Number	Price
NOMAD 10' Frame	
SC-NOMD-BS10	\$5,641
NOMAD 12' Frame	
SC-NOMD-BS12	\$6,399

- Bases and frames are constructed of steel with a white powdercoat finish.
- Includes locking casters.
- Shipped in pieces and require assembly.

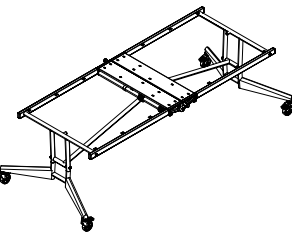

how to order

Replace "???" with "T1" for standard TFL, "T2" for premium TFL, "H1" for standard HPL or "H2" for premium HPL. On your order, please specify edgeband finish if different than the top finish. See pages 4-5 for finish options.

NOMAD^{sport} pricing

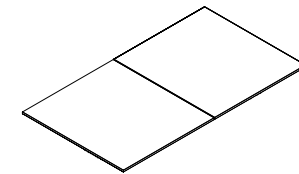

Table Tops

Model Number	Width	Length	H1	H2
SC-NMSP-6008-??-A1	60	108	\$3,576	\$4,220

Frame

Model Number	Price
SC-NOMD-BSS9	\$6,007

- Bases and frames are constructed of steel with a white powdercoat finish.
- Includes locking casters.
- Shipped in pieces and require assembly.
- Includes ping pong set.

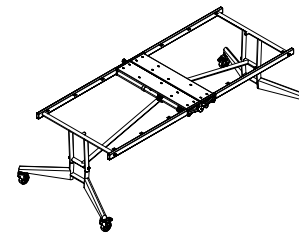

EYHOV^{sport} pricing



Table Tops

Model Number	Width	Length	H1	H2
SC-THTK-6008-??-A1	60	108	\$3,406	\$4,014

- Sport tables only available in HPL for maximum durability.
- HPL tops with 2mm PVC edges are only available with Scale 1:1 standard 2MM PVC edgebanding.
- For electrical options, please see pages 28-36. Electrical units should be installed in "CV" position to avoid conflict with net or game play.
- Ping Pong Set sold separately (SC-PING-PONG)

Frame

Model Number	Table Width	Table Length	Base Size	# of Legs	Price
SC-BDH2-4420	54, 60	108, 120	43-1/2	2	\$3,304

- Bases and frames are constructed of steel with a white powdercoat finish.
- Shipped in pieces and require assembly.



Ping-Pong Set

Model Number	Price
SC-PING-PONG	\$134



how to order

Replace "???" with "T1" for standard TFL, "T2" for premium TFL, "H1" for standard HPL or "H2" for premium HPL. On your order, please specify edgeband finish if different than the top finish. See pages 4-5 for finish options.

Electrical

Placement Guides

NOMAD 12Ft/10Ft

Surface Mounted
4 Power Outlet

Jumper

Surface Mounted
4 Power Outlet

Starter Cable
with 72" Wall Plug

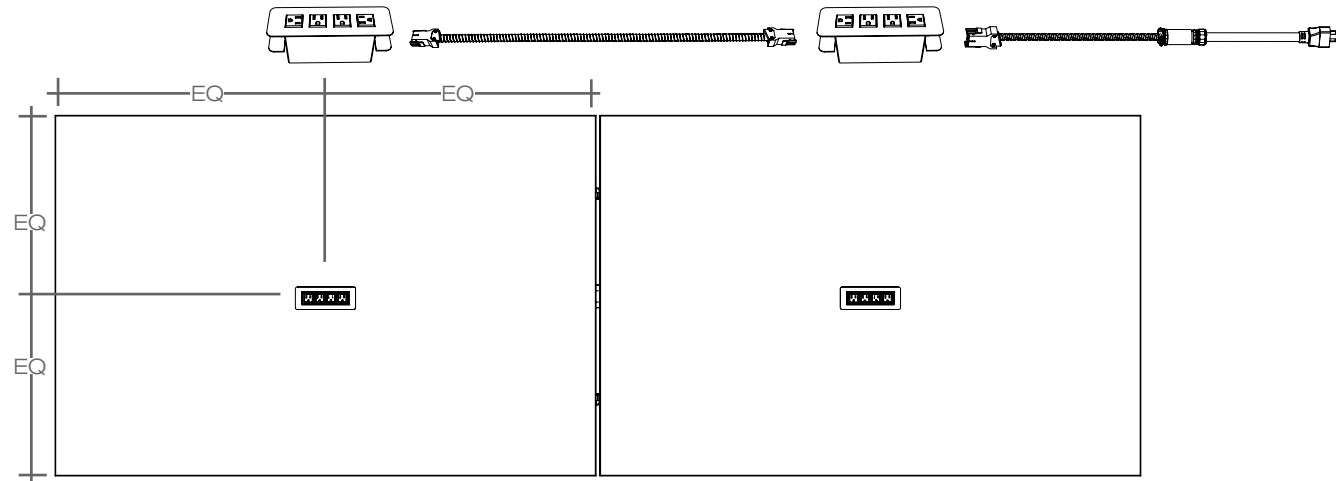

NOMAD Sport

Surface Mounted
3 Outlet Power unit
with Jumper 12"

Surface Mounted 3 Outlet Power unit
with Jumper 12" & Starter Cable with 72" Wall Plug

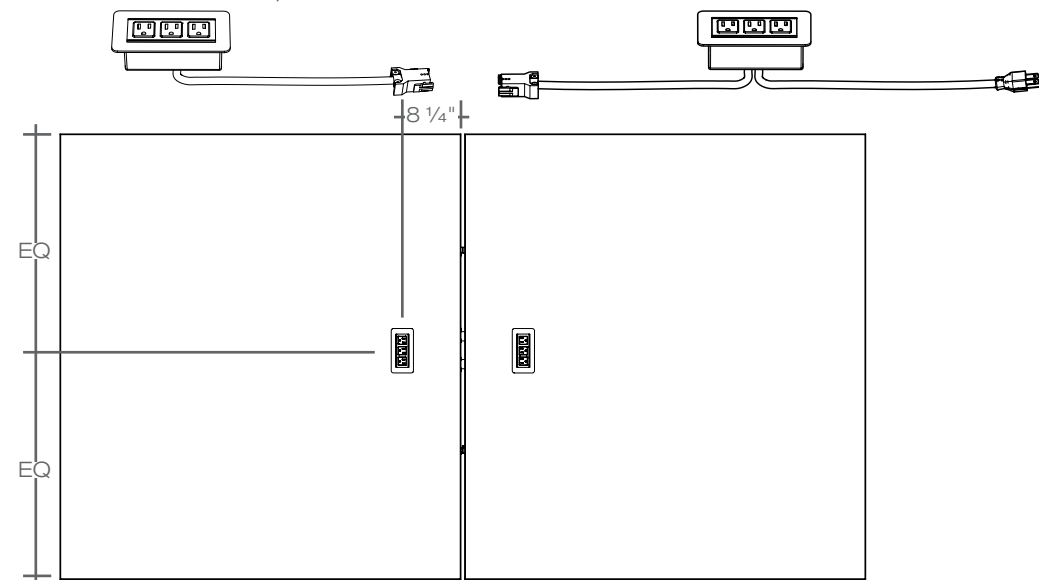

Model Number	Color	Price
AC-ELEC-NM10-WT	white	\$2,078
AC-ELEC-NM12-WT	white	\$2,094
AC-ELEC-NMSP-WT	white	\$1,223

- Nomad Tables require specific electrical kit to accommodate the folding mechanism.
- The placement of the Nomad Sport Electrical Kit (AC-ELEC-NMSP-WT) is designed to be unobtrusive when the table is used as a ping pong table. This electrical kit can be installed on the stationary EYHOV Sport as well.

Electrical

Placement Guides

Telemeet

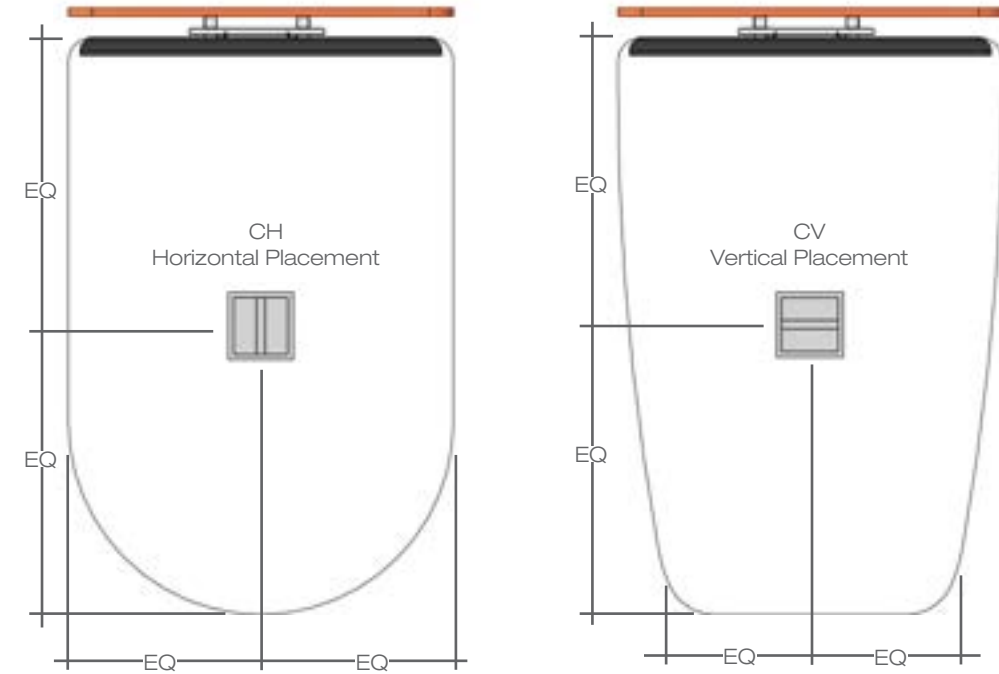

All Scale 1:1 Tables

Refer to the Conference Table Grommet Guide on the DeskMakers Website for Grommet locations. The Electrical Grommets listed on the following pages are compatible with all Scale 1:1 Conference Tables in either horizontal or vertical orientation - additional options are available in the DeskMakers Electrical Pricebook but may not be suitable for all applications. 36"-48" wide table will have 9 1/2" clear in the center between support struts. Tables 54"-60" will have 24" clear. Please confirm with customer service if specifying electrical other than what is included in this pricebook. Electrical units on EYHOV Sport should always be in the CV position to avoid conflict with the net and game play.

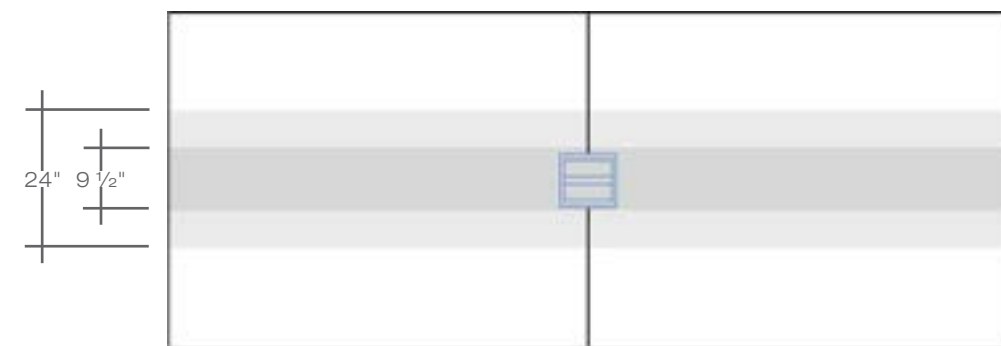

Electrical

AC-DPGR-78 : Pop-up Power and Data Unit with USB Charging



Specifications

- (3) power outlets
- (2) 2.1A USB charging ports
- (2) 45W USBC charging ports
- (1) RJ-45 Cat 6 Data port
- (1) HDMI port
- (1) Open data port
- (2) 120" long 15amp plug cords
- Available finishes: White and Silver

Recommended Use

- All Conference Tables
- EYHOV Sport in CV position
- TeleMeet Collection
- Not Recommended for Nomad
- Not Recommended for Training Tables

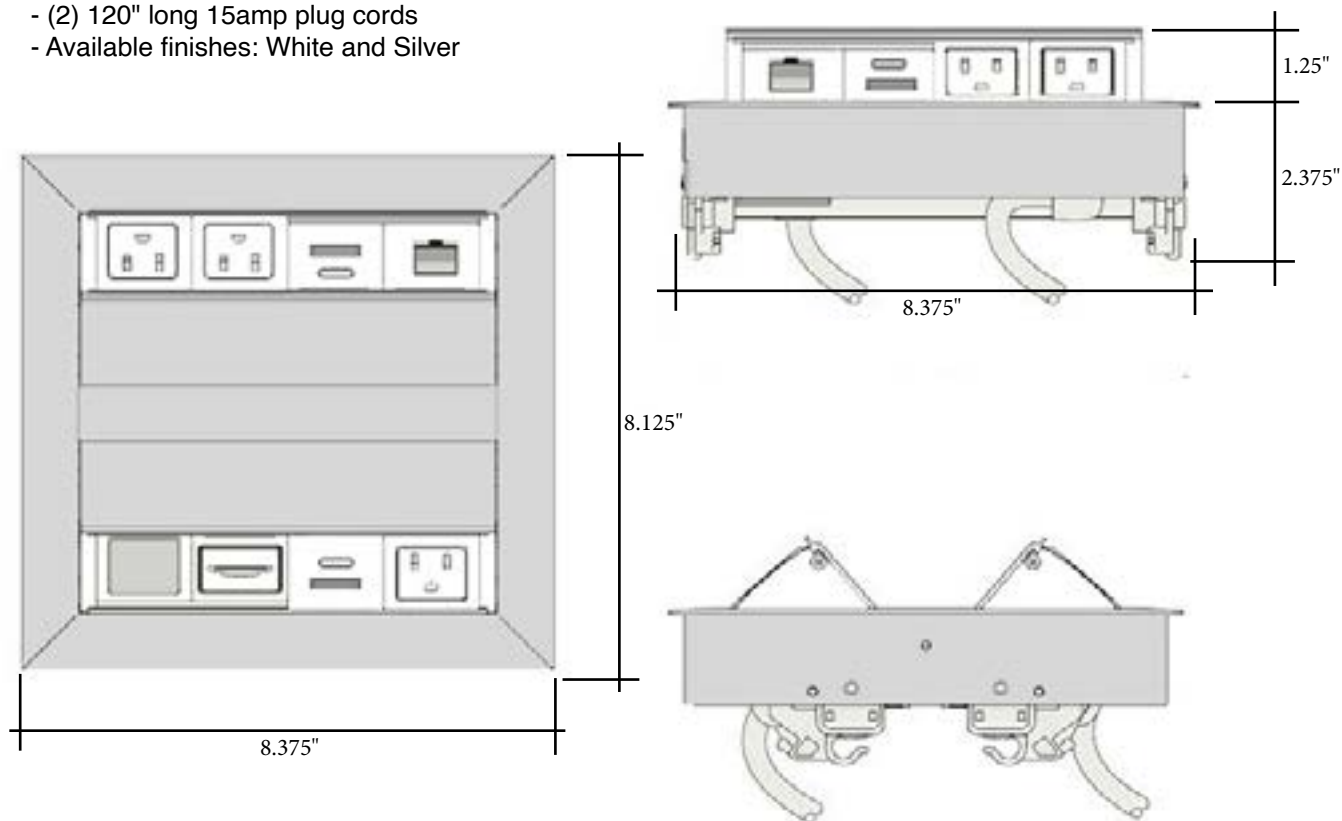

Model Number	Color	Price
AC-DPGR-78-WT	white	\$1,851

AC-DPGR-79 : Recessed Power and Data Unit with USB Charging



Specifications

- (4) power outlets
- (2) 2.1A USB charging ports
- (2) 45W USBC charging ports
- (1) RJ-45 Data port
- (1) HDMI port
- (2) 120" long 15amp plug cords
- Available finishes: White, and Silver

Recommended Use

- All Conference Tables
- EYHOV Sport in CV position
- TeleMeet Collection
- Not Recommended for Nomad
- Not Recommended for Training Tables

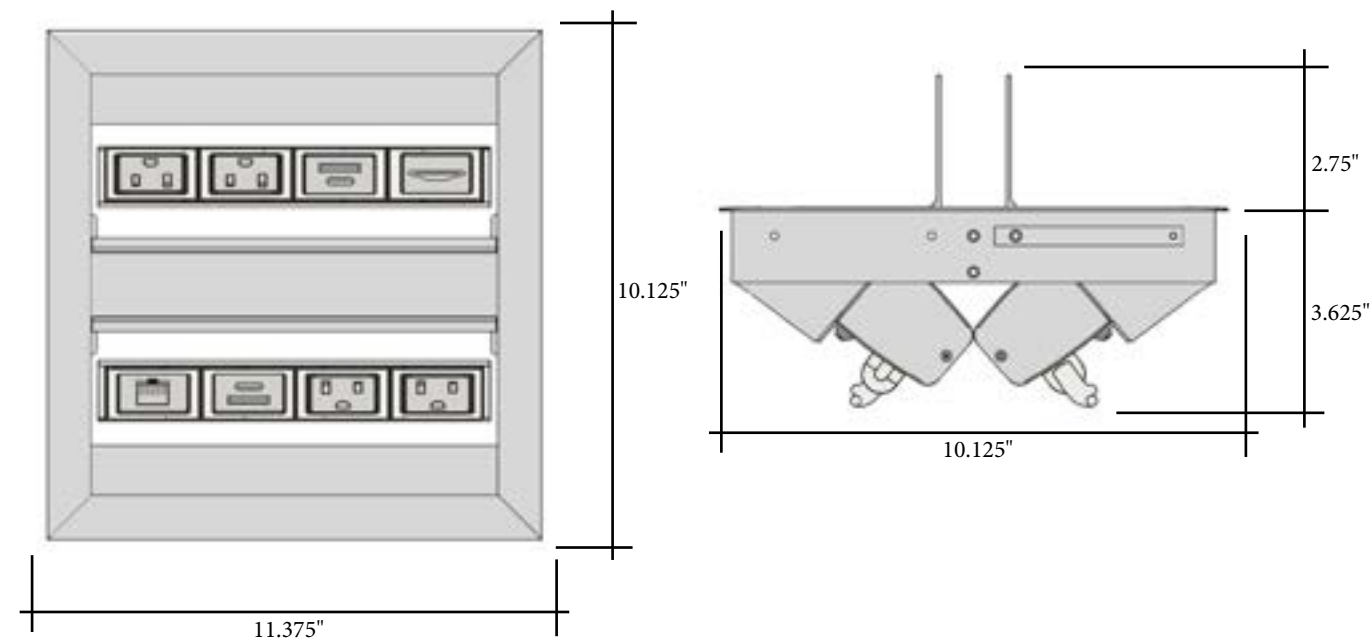

Model Number	Color	Price
AC-DPGR-79-WT	white	\$1,987

Electrical

AC-PWRG-08 : Flipping Power and Data Unit with USB Charging



Specifications

- (2) power outlets
- (1) 2.1A USB charging ports
- (1) USB-C charging port
- (1) 72" long 15amp plug cord
- Twist-in toolless install
- Available finishes: Black, Grey, and White

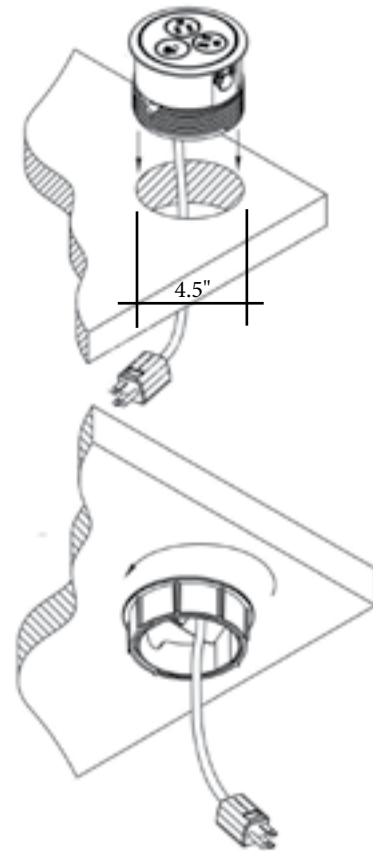

Model Number	Color	Price
AC-PWRG-08-BK	black	\$504
AC-PWRG-08-GY	grey	\$504
AC-PWRG-08-WT	white	\$504

Electrical

AC-PWRG-02 & 06: Grommet Power with USB Charging



Specifications

- Round 3" grommet hole
- (2) Spill resistant power outlets
- (3) 2.1A USB charging ports
- (1) USB-C charging port
- (1) 72" long 15amp plug cord
- (1) Convenience outlet underneath unit
- Mounting Ring
- Available finishes: Black, and White

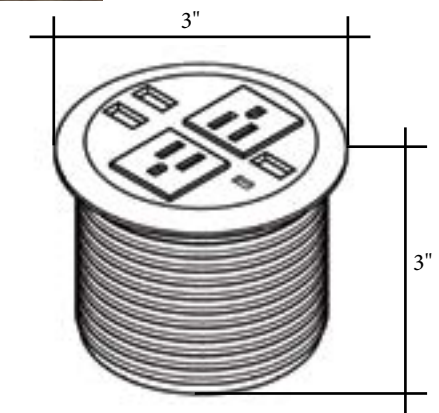

Specifications

- Round 2-2.5" grommet hole
- (1) Spill resistant power outlets
- (2) 2.1A USB charging ports
- (1) 84" long 15amp plug cord
- Mounting Ring
- Available finishes: Black, Silver and White

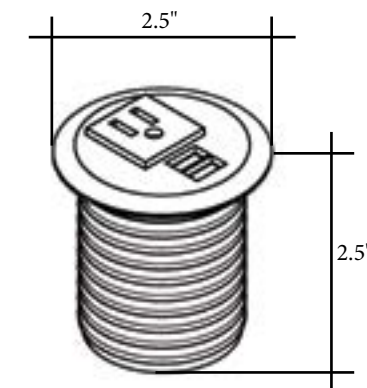

Model Number	Color	Price
2 1/2" Power Grommet		
AC-PWRG-02-WT	white	\$105
AC-PWRG-02-BK	black	\$105
3" Power Grommet		
AC-PWRG-06-WT	white	\$137
AC-PWRG-06-BK	black	\$137

Electrical

Round Grommet



Model Number	Description	Price
AC-GROM-1	2.5" black plastic grommet	\$54
AC-GROM-2	2.5" white plastic grommet	\$54
AC-GROM-6	2.5" stainless steel grommet	\$74

- Reference grommet guides for grommet placement.

Rectangle Grommet



Model Number	Description	Price
AC-GROM-35	3 3/4" x 2 1/4" stainless steel grommet	\$80

- Reference grommet guides for grommet placement.

V2 System Hinged Grommet



Model Number	Description	Price
AC-ELV2-08-BL	5.7" x 3.4" black hinged grommet	\$208
AC-ELV2-08-PL	5.7" x 3.4" silver hinged grommet	\$161
AC-ELV2-08-WT	5.7" x 3.4" white hinged grommet	\$208
AC-ELV2-08-ST	5.7" x 3.4" brushed stainless hinged grommet	\$278

- Reference grommet guides for grommet placement.

Large Hinged Grommet



	Description	Price
AC-ELV2-LG-BK	8" x 4" black hinged grommet	\$222
AC-ELV2-LG-PL	8" x 4" silver hinged grommet	\$222
AC-ELV2-LG-WT	8" x 4" white hinged grommet	\$222

- Reference grommet guides for grommet placement.

Cable Spine Wire Manager



Model Number	Color	Length	Price
AC-MGMT-CS50-BK	black	50"	\$140
AC-MGMT-CS50-SV	silver	50"	\$140
AC-MGMT-CS50-WT	white	50"	\$140

- Plastic material. Includes mounting bracket, and metal base plate. Links easily disconnect to adjust length.
 - Links are 1 1/4" x 2-1/2".
 - Appropriate for use with height adjustable or fixed height tables.

Electrical

G-Shaped Plastic Wire Management Channel



Model Number	Length	Price
AC-MGMT-GCHN	per 8 linear feet	\$87

- Channel size is 1-1/2" x 1-1/2".
 - Secures with screws, staples or double-sided tape.
 - Flexible corner opening for easy insertion of wires.
 - Supplied in 8-foot increments only. Must be field installed.

Cable Tray



Model Number	Width	Length	Height	Price
AC-MGMT-TRAY-20	2 1/2"	20"	3 1/2"	\$88
AC-MGMT-TRAY-32	2 1/2"	32"	3 1/2"	\$108
AC-MGMT-TRAY-44	2 1/2"	44"	3 1/2"	\$130
AC-MGMT-TRAY-56	2 1/2"	56"	3 1/2"	\$199
AC-MGMT-TRAY-68	2 1/2"	68"	3 1/2"	\$235

- Silver (Aluminum).
 - Mounts under desktop with woodscrews (included).
 - Low-profile wire tray ideal for use under height adjustable desks.

Wire Management Basket



Model Number	Color	Price
SC-STCB-B	black	\$116

- Mounting brackets are integrated into basket for ease of installation.
 - Silver finish.
 - Size: 7"x30"x4.25"H

Flex Wire Manager



Model Number	Width	Length	Price
AC-MGMT-FLEX	1 1/2"	5 3/8"	\$18

- Price is for one unit.
 - Secures with single screw.
 - Grey plastic.

Velcro Wire Manager



Model Number	Width	Length	Price
AC-MGMT-VELCRO	1 3/4"	3 1/2"	\$24

- Price is for one unit.
 - Secures with double-sided tape.
 - Black plastic and black velcro.

Please visit DeskMakers.com to view our current [Terms and Conditions](#).

Please visit DeskMakers.com to view our current [Warranty](#).



Los Angeles
Deskmakers Headquarters
6525 Flotilla Street
Commerce, CA 90040

scale 1:1

Phone: 323.264.2260 | Fax: 323.725.6960
www.deskmakers.com
www.scale1to1.com